

ELECTRIC INSERT FIREPLACE HEATER OWNERS MANUAL

Model Numbers: Costa Challenger

COSTA

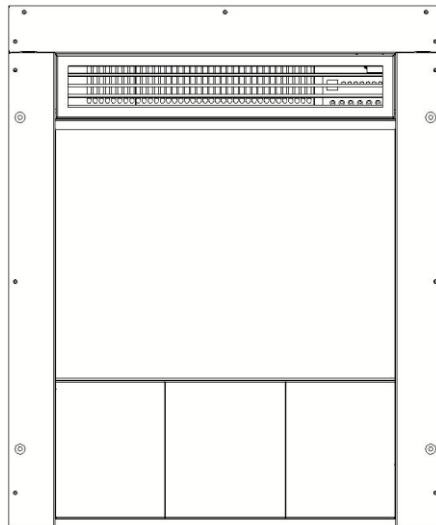

AC 220-240V 50Hz 1400-1600W

⚠ WARNING

Read and understand this entire owner's manual, including **all safety information, before plugging in or using** this product. Failure to do so could result in **fire, electric shock, or serious personal injury.**

⚠ CAUTION

Keep this owner's manual for future reference. If you sell or give this product away, **make sure this manual accompanies this product.**



IMPORTANT SAFETY INFORMATION!

WARNING

When using electrical appliances basic precautions should always be followed to reduce the risk of fire, electric shock and injury to persons, including the following:

- Read all instructions before using this heater.
- This heater is hot when in use. To avoid burning, do not touch hot surface. If provided, use handles when moving this heater. Keep combustible materials, such as furniture, pillows, bedding, papers, clothes, and curtains at least 1 m from the front of the heater and keep them away from the sides and rear. In order to avoid overheating, do not cover the heater.
- Extreme caution is necessary when any heater is used near children or the infirm and whenever the heater is left operating and unattended.
- Always unplug heater when not in use.
- Do not operate any heater with a damaged cord or plug or after the heater malfunctions, has been dropped damaged in any manner, return heater to authorized service facility for examination, electrical or mechanical adjustment, or repair.
- Indoor use only, do not use outdoors.
- This heater is not intended for use in bathrooms, laundry areas and similar indoor locations. Never locate heater where it may fall into a bathtub or other water container.
- Do not run cord under carpeting. Do not cover cord with throw rugs, runners, or similar coverings. Arrange cord away from traffic area and where it will not be tipped over.
- To disconnect heater, turn controls to off, then remove plug from outlet.
- Do not inset or allow foreign objects to enter any ventilation or exhaust opening as this may cause an electric shock or fire, or damage the heater.
- To prevent a possible fire, do not block air intakes or exhaust in any manner. Do not use on soft surfaces, like a bed, where openings may become blocked.
- A heater has hot and arcing or sparking parts inside. Do not use it in areas where gasoline, or flammable liquids are used or stored.
- Use this heater only as describes in this manual. Any other use not recommended by the manufacturer may cause fire, electric shock, or injury to persons.
- DANGER-HIGH Temperatures may be generated under certain abnormal conditions. Do not partially or fully cover or obstruct the front of this heater.
- Replacement of the lamps should be done only while the heater is disconnected from the supply circuit.
- This appliance is not intended for use by persons (including children) with reduced physical, sensory or capabilities, or lack of experience and knowledge, unless they have been given supervision or instruction concerning use of the appliance by a person responsible for their safety. Children should be supervised to ensure that they do not play with the appliance.
- CAUTION: In order to avoid a hazard due to inadvertent resetting of the thermal cut-out, this appliance must not be supplied through an external switching device, such as a timer, or connected to a circuit that is regularly switched on and off by the utility.

Preparation







This product includes a **GLASS panel!** Always use **extreme caution** when **using**. Failure to do so could result in **personal injury** or **property damage**.

Remove all parts and hardware from the carton and place them on a clean, soft, dry surface. Check the parts list to make sure nothing is missing. Dispose of packaging materials properly. Please recycle whenever possible.

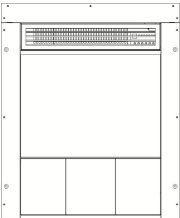
You will need the following tools (not included): Phillips screwdriver.

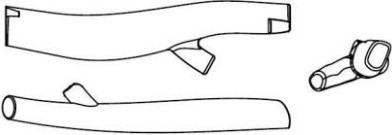
Parts and Hardware

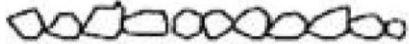
 <p>A – Fireplace (1)</p>	 <p>D – ST4x12 Metal Screws (4)</p>	 <p>D- Instruction Manual (1)</p>
 <p>E- Log pieces</p>	 <p>F- Crystals (Clear, Black)</p>	 <p>G - Pebbles</p>

Specification and Dimension

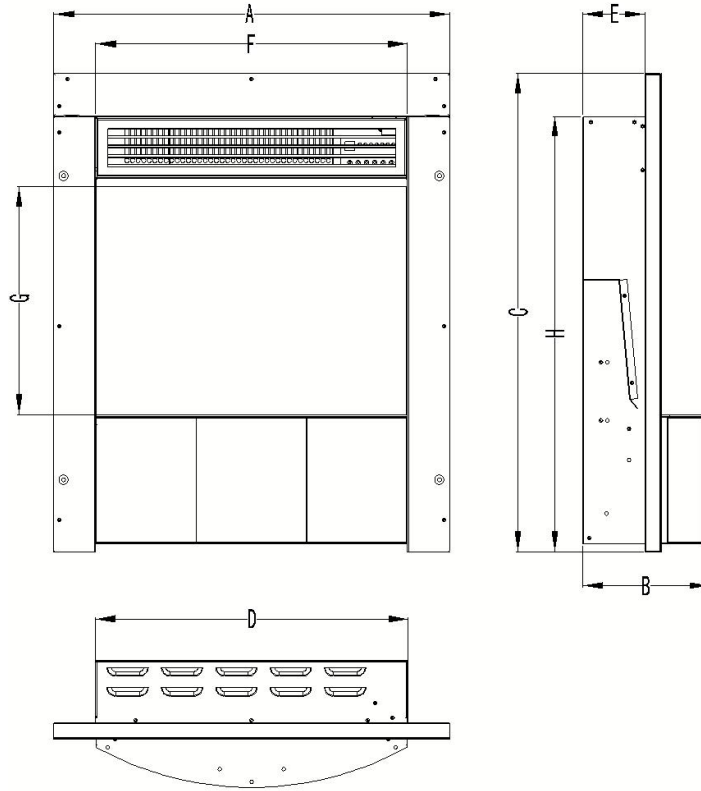

PRODUCT DIMENSIONS								
Model Number	A	B	C	D	E	F	G	H
Challenger	19.5" 49.5cm	6.25" 15.9cm	23.5" 59.8cm	15.4" 39.1cm	3.1" 7.7cm	15.35" 39cm	11.2" 28.4cm	21.4" 54.4cm

Installation and Assembly

Your appliance is a recessed and/or mantel installed appliance. Select a suitable location that is not susceptible to moisture and is away from drapes, furniture and high traffic areas.

NOTE: Follow all National and local electrical codes.

MINIMUM CLEARANCE TO COMBUSTIBLES

Measurements are taken from the glass front.			
Bottom	0"	Top	8" (300mm) to mantel
Sides	0"	Top	8" (300mm) to ceiling
Back	0"		

MINIMUM MANTEL CLEARANCES

WARNING

WHEN USING PAINT OR LACQUER TO FINISH THE MANTEL, THE PAINT OR LACQUER MUST BE HEAT RESISTANT TO PREVENT DISCOLOURATION.

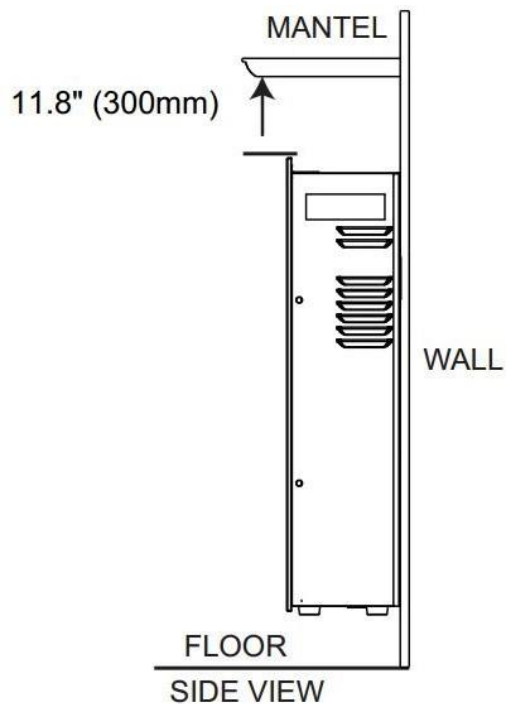

Logset / Crystal / Pebble Ember Installation

(Note: Crystals have two types, clear and black colors, decorate the way that you like)

- A. Carefully place crystals, pebbles embers into the bottom tray on the front of the appliance as illustrated. Apply an even layer from side to side. **Figure 1, Figure 2.**
- B. Place the decorative log pieces on the surface of the crystals or pebbles **Figure 3.**



Figure 1. (Crystals media)



Figure 2. (Pebbles media)



Figure 3. (Log pieces media)

Operation



Read and understand this entire owner's manual, including **all safety information**, before plugging in or using this product. Failure to do so could result in **electric shock, fire, serious injury, or death.**

Power

Plug the power cord into a 220-240V 50Hz outlet (see **IMPORTANT SAFETY INFORMATION** on **Pages 2 and 3**). Make sure the outlet is in good condition and that the plug is not loose. **NEVER** exceed the maximum amperage for the circuit. **DO NOT** plug other appliances into the same circuit.





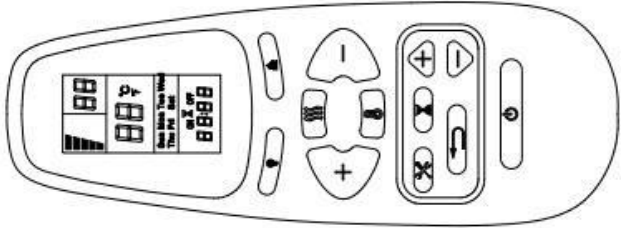
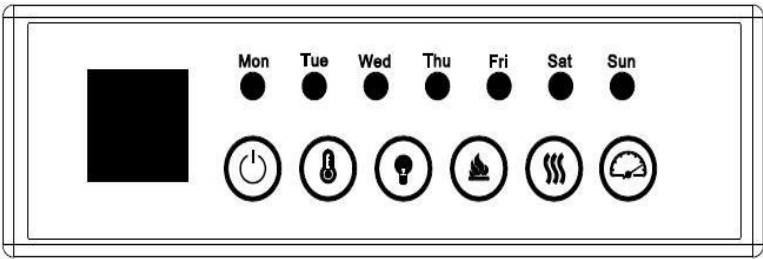
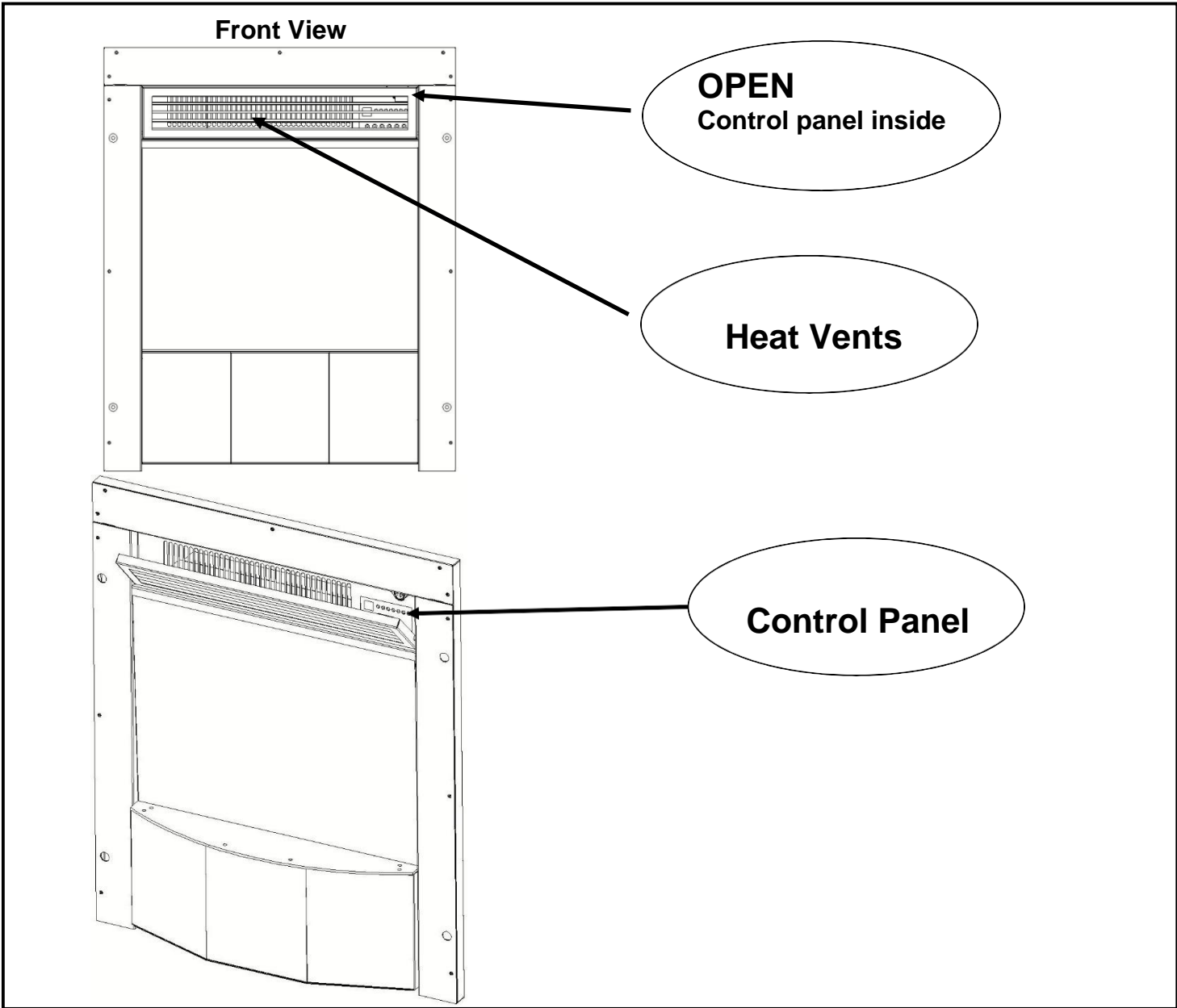

Methods of Operation

This electric fireplace can be operated by the CONTROL PANEL, located on the Front of the fireplace (see figure below), or by the battery-powered REMOTE CONTROL.

Before operating, please review the **IMPORTANT SAFETY INFORMATION** on **Pages 2 and 3**, and heed all warnings.







Control Panel / Remote Control Operation

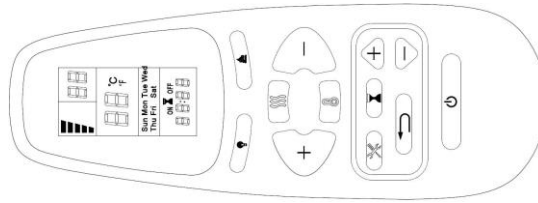

BUTTON	FUNCTION	ACTION & INDICATION																																																								
 POWER	ON: Enables control panel functions and remote control. Turns on flame effect. OFF: Disables control panel functions and remote control. Turns off flame effect.	<ol style="list-style-type: none"> Press once. Indicator light turns on. Power turns on. All functions enabled. Press again. Flame effect turns off. Power and all functions turn off. 																																																								
	FLAME button: Makes flame effect dimmer and brighter. NOTE: Flame effect stays on until power button is turned off. Flame effect must be	<ol style="list-style-type: none"> Press once. Indicator light turns on. Flame brightness effect starts changing. Press again. until desired setting is reached. 																																																								
	COLOUR button: Makes the colour flame effect changing. NOTE: Colour effect stays on until power button is turned off. Colour flame effect must be on for heater to turn on.	<ol style="list-style-type: none"> Press once. Indicator light turns on. Flame colour effect gets changing. Press again. until desired setting is reached. Display window shows setting. 																																																								
	Flame speed button: Makes the flame speed changing. NOTE: Flame speed effect stays on until power button is turned off.	<ol style="list-style-type: none"> Press once. Indicator light turns on. Flame speed effect gets changing. Press again. until desired setting is reached. 																																																								
 HEATER	HEATER button: Turns heater on and off. NOTE: The heater only works when the flame effect is on. If the flame effect is off, the heater will not turn on. NOTE: To prevent overheating, the heater blows cool air for 10 seconds before the heater turns on, and after it turns off.	<ol style="list-style-type: none"> Press once. Indicator lights up. Fan blows cool air for 10 seconds. Low heater turns on and blows warm air. Press again. Indicator lights up. High heater turns on and blows hot air. Press again. Heaters turn off. The fan blows cool air, then turns off. 																																																								
 TEMP	TEMPERATURE button: Turns heater on and off. NOTE: Press & Hold the button for 5 seconds, the temperature setting will switch from °C to °F. Same way from °F to °C.	<ol style="list-style-type: none"> Press once. Indicator lights up. Temperature goes to 18 °C Press again. until desired setting is reached. Digital display shows setting circles as below: 																																																								
	<table border="1"> <thead> <tr> <th>NO</th> <th>0</th> <th>1</th> <th>2</th> <th>3</th> <th>4</th> <th>5</th> <th>6</th> <th>7</th> <th>8</th> <th>9</th> <th>10</th> <th>11</th> <th>12</th> </tr> </thead> <tbody> <tr> <td>°C</td> <td>18</td> <td>19</td> <td>20</td> <td>21</td> <td>22</td> <td>23</td> <td>24</td> <td>25</td> <td>26</td> <td>27</td> <td>28</td> <td>29</td> <td>30</td> </tr> <tr> <td>°F</td> <td>64</td> <td>66</td> <td>68</td> <td>70</td> <td>72</td> <td>74</td> <td>76</td> <td>78</td> <td>80</td> <td>82</td> <td>84</td> <td>86</td> <td>88</td> </tr> <tr> <td></td> <td>65</td> <td>67</td> <td>69</td> <td>71</td> <td>73</td> <td>75</td> <td>77</td> <td>79</td> <td>81</td> <td>83</td> <td>85</td> <td>87</td> <td></td> </tr> </tbody> </table>	NO	0	1	2	3	4	5	6	7	8	9	10	11	12	°C	18	19	20	21	22	23	24	25	26	27	28	29	30	°F	64	66	68	70	72	74	76	78	80	82	84	86	88		65	67	69	71	73	75	77	79	81	83	85	87		
NO	0	1	2	3	4	5	6	7	8	9	10	11	12																																													
°C	18	19	20	21	22	23	24	25	26	27	28	29	30																																													
°F	64	66	68	70	72	74	76	78	80	82	84	86	88																																													
	65	67	69	71	73	75	77	79	81	83	85	87																																														



Remote Control Operation



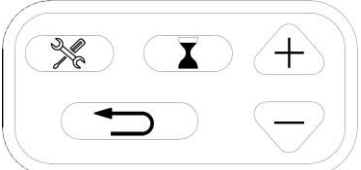

BUTTON	FUNCTION	ACTION & INDICATION
 POWER	ON: Enables control panel functions and remote control. Turns on flame effect. OFF: Disables control panel functions and remote control. Turns off flame effect.	<ol style="list-style-type: none"> Press once. Indicator light turns on. Power turns on. All functions enabled. Press again. Flame effect turns off. Power and all functions turn off.
	COLOUR button: Makes the colour flame effect changing. NOTE: Colour effect stays on until power button is turned off. Colour flame effect must be on for heater to turn on.	<ol style="list-style-type: none"> Press once. Indicator light turns on. Flame colour effect starts changing. Press again until desired setting is reached. Display window shows setting.
	FLAME button: Makes flame effect dimmer and brighter. NOTE: Flame effect stays on until power button is turned off. Flame effect must be on for heater to turn on.	<ol style="list-style-type: none"> Press once. Indicator light turns on. Flame brightness effect gets changing. Press again. until desired setting is reached.
 HEATER	HEATER button: Turns heater on and off. NOTE: The heater only works when the flame effect is on. If the flame effect is off, the heater will not turn on. NOTE: To prevent overheating, the heater blows cool air for 10 seconds before the heater turns on, and after it turns off.	<ol style="list-style-type: none"> Press once. Indicator lights up. Fan blows cool air for 10 seconds. Low heater turns on and blows warm air. Press again. Indicator lights up. High heater turns on and blows hot air. Press again. Heaters turn off. The fan blows cool air, then turns off.

TIMER SETTINGS ON REMOTE CONTROL

 : Timer: Displays current day, time, and week. Press to enter or confirm timer settings.	
 : Settings: Press to move to next step (use with Timer button). Press to confirm week timer.	
 : Back: Press to clear timer settings. Press to return to the previous step (use with Settings button).	





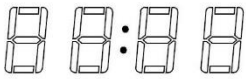

 :**Up and Down** (use with Settings button).

LCD Screen





<p>Weekday  → Mon, Tues, Wed, Thurs, Fri, Sat, Sun</p>	<p>Sun Mon Tue Wed Thu Fri Sat</p>	<p>Note: The functions can only be adjusted when the related letters or digits are flashing.</p>
<p>Time Display  →</p>	<p>ON  OFF</p> 	
<p>Current Time / Timer From 00:00 to 24:00 NOTE: 00-12:00 is AM / 13:00-24:00 is PM</p>		

 TEMP	<p>TEMPERATURE button: Turns heater on and off. NOTE: Press & Hold the button for 5 seconds, the temperature setting will switch from °C to °F. Same way from °F to °C.</p>	<p>1. Press once: Indicator lights up. Temperature goes to 18 °C 2. Press again: until desired setting is reached. Digital display shows setting circles as below:</p>																																																							
			<table border="1"> <tr> <th>NO</th><th>0</th><th>1</th><th>2</th><th>3</th><th>4</th><th>5</th><th>6</th><th>7</th><th>8</th><th>9</th><th>10</th><th>11</th><th>12</th> </tr> <tr> <td>°C</td><td>18</td><td>19</td><td>20</td><td>21</td><td>22</td><td>23</td><td>24</td><td>25</td><td>26</td><td>27</td><td>28</td><td>29</td><td>30</td> </tr> <tr> <td>°F</td><td>64</td><td>66</td><td>68</td><td>70</td><td>72</td><td>74</td><td>76</td><td>78</td><td>80</td><td>82</td><td>84</td><td>86</td><td>88</td> </tr> <tr> <td></td><td>65</td><td>67</td><td>69</td><td>71</td><td>73</td><td>75</td><td>77</td><td>79</td><td>81</td><td>83</td><td>85</td><td>87</td><td></td> </tr> </table>	NO	0	1	2	3	4	5	6	7	8	9	10	11	12	°C	18	19	20	21	22	23	24	25	26	27	28	29	30	°F	64	66	68	70	72	74	76	78	80	82	84	86	88		65	67	69	71	73	75	77	79	81	83	85
	NO	0	1	2	3	4	5	6	7	8	9	10	11	12																																											
	°C	18	19	20	21	22	23	24	25	26	27	28	29	30																																											
°F	64	66	68	70	72	74	76	78	80	82	84	86	88																																												
	65	67	69	71	73	75	77	79	81	83	85	87																																													





1 Set current day and time

1. Press  once. When “MON” (Monday) begins flashing, use  to select the current day.
2. Press . When the hour digits begin flashing, use  to select the current hour.
3. Press  again. When the minute digits begin flashing, use  to select the current minute.
4. Press  again. The current time is now set.

2 Set ON/OFF time and temperature on a weekly cycle









1. Press . When “MON” begins flashing, press  3 times. When “ON” begins flashing, use  to select the desired hour and minute to turn on the heater.  at any time to clear the digits and shut down “ON” timer.

note:
 The timer can only be adjusted in 30-minute intervals (i.e. 00:00 - 00:30; 00:30 - 01:00, etc.)

2. Press . When “OFF” begins flashing, use  to select the desired hour and minute to turn off the heater. Press  at any time to clear the digits and shut down “OFF” timer.
3. Press  again. When “18” begins flashing, use  to select the desired temperature for Monday.

note:
 If the temperature was previously set, those digits will be shown instead of “18”.



4. Press  again. When “TUES” appears on the screen and “ON” begins flashing, use  to select the desired hour and minute to turn on the heater for Tuesday.
5. Press  again. When “OFF” begins flashing, use  to select the desired hour and minute to turn off the heater for Tuesday.
6. Press  again. When “18” begins flashing, use  to select the desired temperature for Tuesday.
7. Repeat steps 1 to 6 to set the “ON/OFF” time and temperature for Wednesday, Thursday, Friday, Saturday, and Sunday.
8. Press  or  to complete programming, ensuring to aim the remote control at the receiver, located in the middle of the appliance. The appliance will “beep” once to confirm that programming has been successful.

Open window warning

If the room temperature decreases by 10 degrees within 3 minutes, the appliance will assume there is an open window nearby. In order to conserve energy, the heater will automatically switch from High Heat to Low Heat, or if the heater is already at Low Heat, it will turn off completely.

When switching from High Heat to Low Heat, the appliance will beep 3 times and the digital display will flash “88” 3 times before displaying the existing heating status.

When switching from Low Heat to Off, the appliance will beep 3 times and the digital display will flash “88” continuously.

To reset the heating function, see “operating remote control” section.

NOTICE

When the heater is first turned on, a slight odour may be present. This is normal and should not occur again unless the heater is not used for a long period of time.

NOTICE

To improve operation, **aim** the remote control at the front of the fireplace. **DO NOT press the buttons too quickly.** Give the unit time to respond to each command.

Temperature Limiting Control

This heater is equipped with a Temperature Limiting Control. Should the heater reach an unsafe temperature, the heater will automatically turn OFF. To reset:

1. Unplug the power cord from the outlet.
2. Turn the ON/OFF switch on the CONTROL PANEL to OFF. **Wait 5 minutes.**
3. Inspect the fireplace to make sure no vents are blocked, or clogged with dust or lint. If they are, use a vacuum to clean the vent areas.
4. With the POWER switch in the OFF position, plug the power cord back into the outlet.
5. If the problem continues, have your outlet and wiring inspected by a professional.

Remote Control Battery Information

- This remote control uses **Two AAA batteries (NOT included).**



NEVER dispose of batteries in **fire**. Failure to observe this precaution **may result in an explosion**. Dispose of batteries at your local hazardous material processing center.

Care and Maintenance

Cleaning



ALWAYS turn the heater **OFF** and **unplug the power cord from the outlet** before cleaning, performing maintenance, or moving this fireplace. Failure to do so could result in **electric shock, fire, or personal injury**.



NEVER immerse in water or **spray with water**. Doing so could result in **electric shock, fire, or personal injury**.

Metal:

- Buff using a soft cloth, slightly dampened with a citrus oil-based product.
- **DO NOT** use brass polish or household cleaners as these products will damage the metal trim.

Glass:

- Use a good quality glass cleaner sprayed onto the cloth or towel. Dry thoroughly with a paper towel or lint-free cloth.
- **NEVER** use abrasive cleansers, liquid sprays, or any cleaner that could scratch the surface.

Vents:

- Use a vacuum or duster to remove dust and dirt from the heater and vent areas.

Plastic:

- Wipe gently with a slightly damp cloth and a mild solution of dish soap and warm water.
- **NEVER** use abrasive cleansers, liquid sprays, or any cleaner that could scratch the surface.

Maintenance



Risk of electric shock! DO NOT OPEN any panels. No user-serviceable parts inside!



ALWAYS turn the heater **OFF** and **unplug the power cord from the outlet** before cleaning, performing maintenance, or moving this fireplace. Failure to do so could result in **electric shock, fire, or personal injury**.

Electrical and Moving Parts:

- The fan motors are lubricated at the factory and will not require lubrication.
- Electrical components are integrated in the fireplace and are not serviceable by the consumer.
- **Storage:**
 - Store heater in a clean dry place when not in use.