

GALLERY CLASSIC 5

INSTALLATION AND OPERATING INSTRUCTIONS

(to be left with the householder)

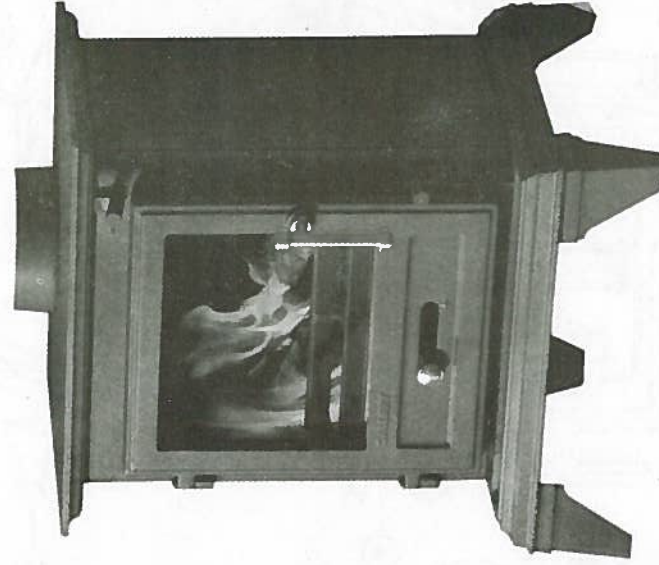

CE APPROVED

This stove operates at very high temperatures. All persons including children and the infirm should be warned of this and not be allowed to touch any surfaces whilst in use. The operator must use the tools provided. The mitten provided is a tool.

Flue Gas Temp at Spigot	Flue Gas Mass Flow	Flue Diam	Ventilation Reqt	Ventilation Reqt with draught stabilizer
402°C	3.9 g/s (wood) 9.7 g/s (ancit)	125mm 5 inches	None	1500mm ² 2.33in ²
As tested to the requirements of EN13240 for intermittent use.				

Output	Output kW Firefox 5	Cycle Hours
Anthracite	4.6	4
Wood Logs (less than 20% moisture)	4.9	1
Coal (E)	4.3	4
Peat (E)	4.7	2
Closed Fire Briquettes	4.6	4
Outputs stated are under ideal test conditions. Variations will occur due to installation, atmospheric conditions and fuel quality. (E) - estimate calculated		

Essential characteristic	Performance
Test fuel	Beech Anthracite
Fire Safety	Pass Pass
Emission of combustion products, related to 13% O ₂	CO: 0.11 vol% CO: 0.17 vol% Dust: 73 mg/m ³ Dust: 86 mg/m ³ NO _x : 98 mg/m ³ C _x H _y : 183 mg/m ³
Surface Temperature	Pass Pass
Thermal output / Energy efficiency	4.9kW / 79.4% 4.5kW / 67.4%
Release of dangerous substances	Pass Pass

Parts List

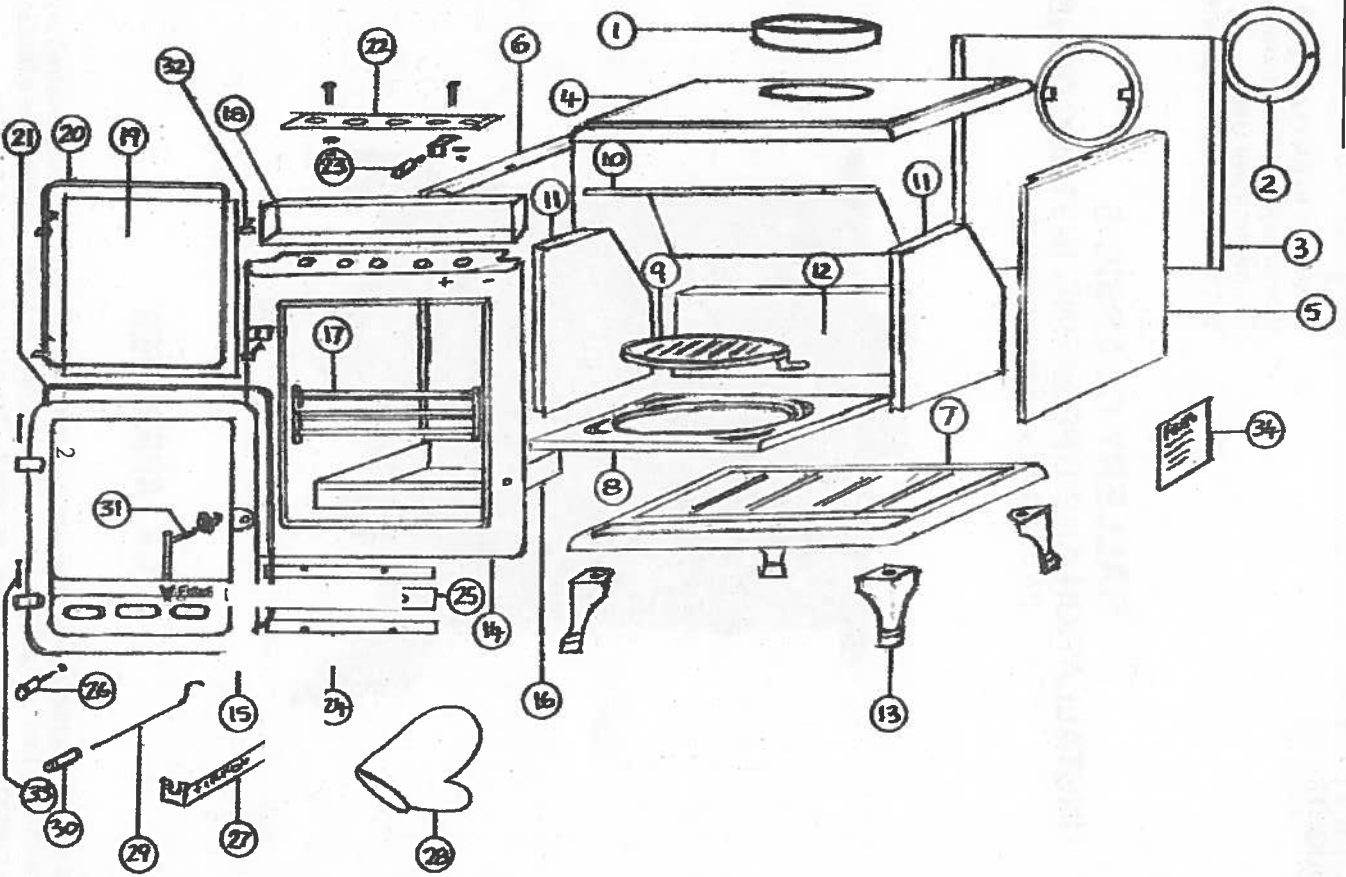

Dimensions

Flue pipe requirement (minimum) diameter:
125mm (5 inch) nominal diameter

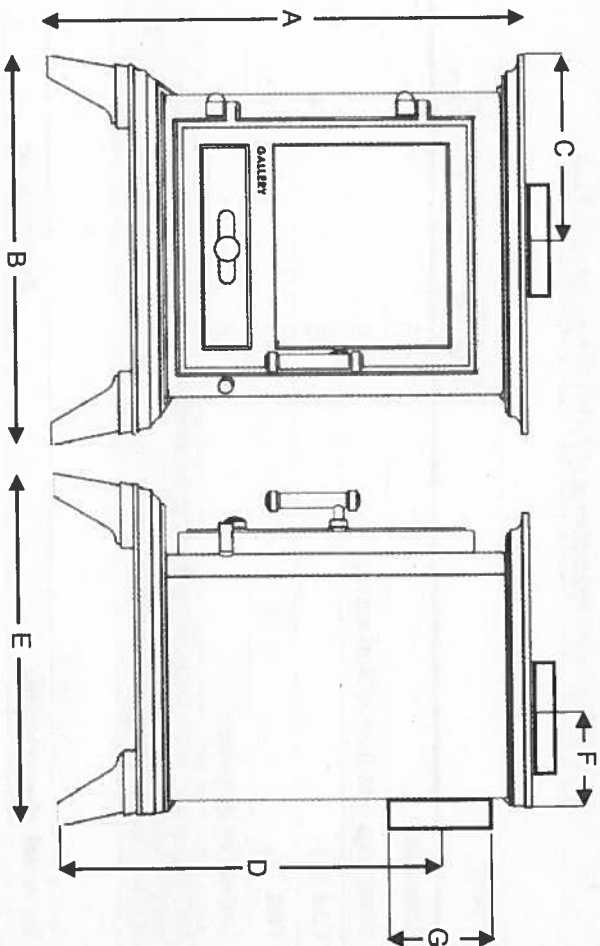

	A	B	C	D	E	F	G	Weight	Max Fuel Load Anthracite	Flue Draught
Dimensions, mm	558	450	210	440	394	99	140	76 Kg	5.33 Kg	Min. 12 Pa Max. 15 Pa 0.048 In Wg

Dimensions may vary slightly, the manufacturers reserve the right to adjust them without notice.

Key To Dimensions

- A—Height
- B—Width
- C—Centrelle of Flue
- D—Height To Centre of Rear Flue
- E—Depth
- F—Rear to Centre of Top Flue
- G—Flue Diameter

15

See back page for flue data, ventilation requirements and stove outputs.

Typical Installation Into Infilled Masonry Fireplaces

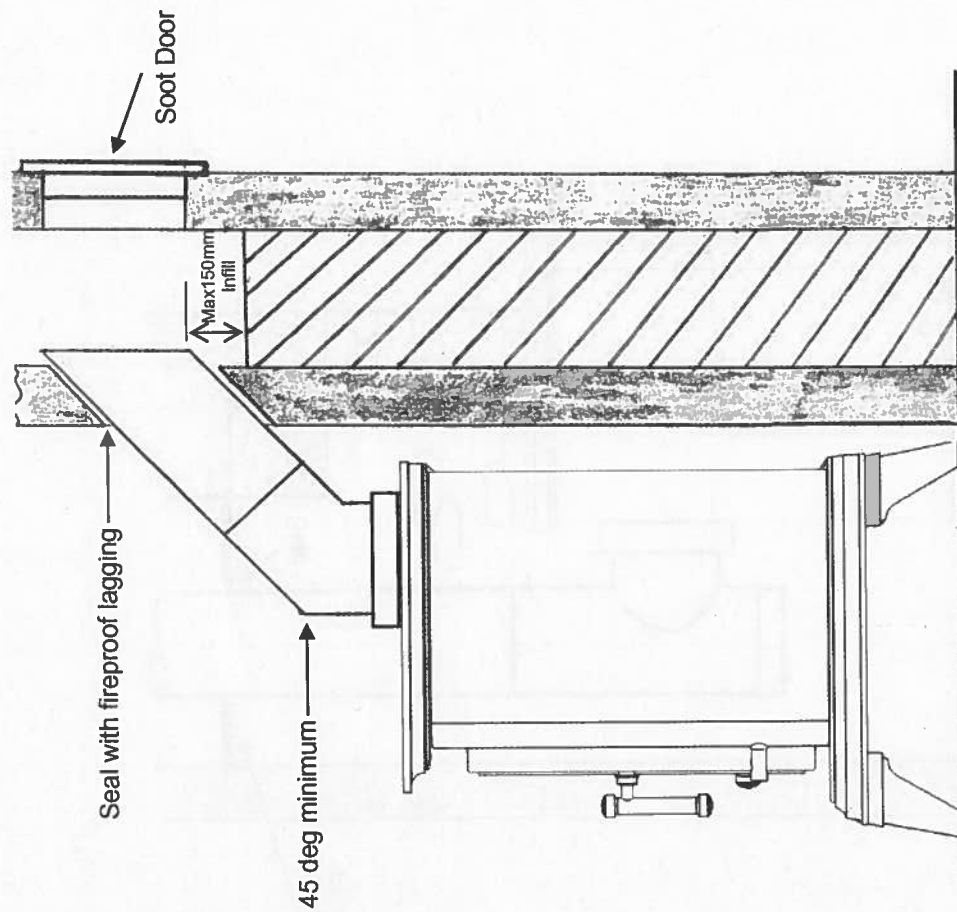

Firefox 5 CB II Parts List

1	FFX008	Flue Collar
2	FFX009	Flue Blanking Plate
3,5,6	FFX001	Stove Body (Rear, Right, Left Panel)
4	FFC003	Stove Top Panel
7	FFC002	Stove Base Panel
8	FFX005	Grate Support Plate
9	FFX006	Grate
10	FFC007	Stove Baffle Plate
11	FFX012	Side Brick
12	FFX013	Back Brick
13	FFC010	Leg
14,15	FFC004	Stove Door + Front Panel
16	FFX014	Ash Pan
17	FFX011	Fret
18	FFC024	Secondary Air Duct
19	FFX018	Door Glass
20	FFX027	Glass Panel Seal
21	FFX026	Door Seal
22	FFX023	Secondary Air Slide
23,26,30	FFC022	Primary, Secondary + Riddling Knob Set
25	FFX020	Primary Air Slide
27	FFX029	Operating Tool
28	FFX1	Mitten
29	FFX015	Grate Riddling Rod
31	FFC016, FFC017	Door Handle Assembly
32	FFX019	Door Glass Retaining Tabs
33	FFX028	Hinge Pin
34	-	Stove Identification Label

Assembly Of Stove

Remove legs, collar and blanking plate from stove and fit in desired position. The collar can be fitted top or rear.

The legs can be fitted at front of ash lip or rearward. To make easier for handling on installation, remove baffle plate, side bricks, back brick and door. Place in a secure place to avoid damage.

Refit after installation.

Stove Installation, Operating & Maintenance Instructions

IMPORTANT: THIS APPLIANCE MUST BE INSTALLED BY A COMPETENT PERSON AND MUST COMPLY WITH NATIONAL BUILDING REGULATIONS AND LOCAL BY-LAWS. UNLESS THE INSTALLER IS QUALIFIED TO APPROVE INSTALLATION THEN APPROVAL MUST BE SOUGHT FROM YOUR LOCAL BUILDING CONTROL DEPARTMENT. THE SUPPLIERS ACCEPT NO RESPONSIBILITY IF THIS ADVICE IS NOT COMPLIED WITH. THIS APPLIANCE HAS BEEN EXTENSIVELY TESTED FOR SAFETY AND EFFICIENCY, DO NOT ATTEMPT TO MODIFY IT. ALWAYS USE GENUINE REPLACEMENT PARTS AS RECOMMENDED BY YOUR SUPPLIER. FAILURE TO ADHERE TO THIS ADVICE COULD INVALIDATE YOUR GUARANTEE. WHEN OPERATING THE STOVE IN A SMOKE CONTROLLED AREA, ONLY BURN SEASONED WOOD AND APPROPRIATE SMOKELESS FUELS.

Installation Instructions

Check the chimney is in good condition, dry, free from cracks and obstructions. The diameter of the chimney flue should not be less than 150mm and not more than 230mm. If any of these requirements are not met, the chimney should be lined by a suitable method.

The chimney height and the position of the chimney terminal should conform to Building Regulations.

A flue draught of minimum 12 Pascals and a maximum of 15 Pascals water gauge is required for satisfactory appliance performance. The flue draught should be checked under fire at high output and if it exceeds the recommended maximum, a draught stabiliser must be fitted so that the rate of burning can be controlled, and to prevent overfiring.

If you have any doubts about the suitability of your chimney, consult your local dealer/stockist.

The chimney must be swept before connection to the stove and swept every six months thereafter. If there is an excessive build up of soot, then the chimney must be swept and the reason for build up investigated.

An existing fireplace opening can be bricked up or sealed with a register plate, 1.5mm steel sheet or concrete. A short length of flue pipe no smaller in diameter than the stove flue outlet or the manufacturer's stated flue size may then be used to connect the stove to the chimney. This flue pipe should be of cast iron, 316 grade stainless steel or vitreous enamelled, nominal thickness 1.2mm. Ensure that the pipe end is no closer than 76mm to the side or rear chimney walls.

Typical Installation For Inglenook Fireplaces

Inglenook fireplaces can have very large bore chimneys. Check with your installer—you may need a stainless steel flexible liner for solid fuel fitting.

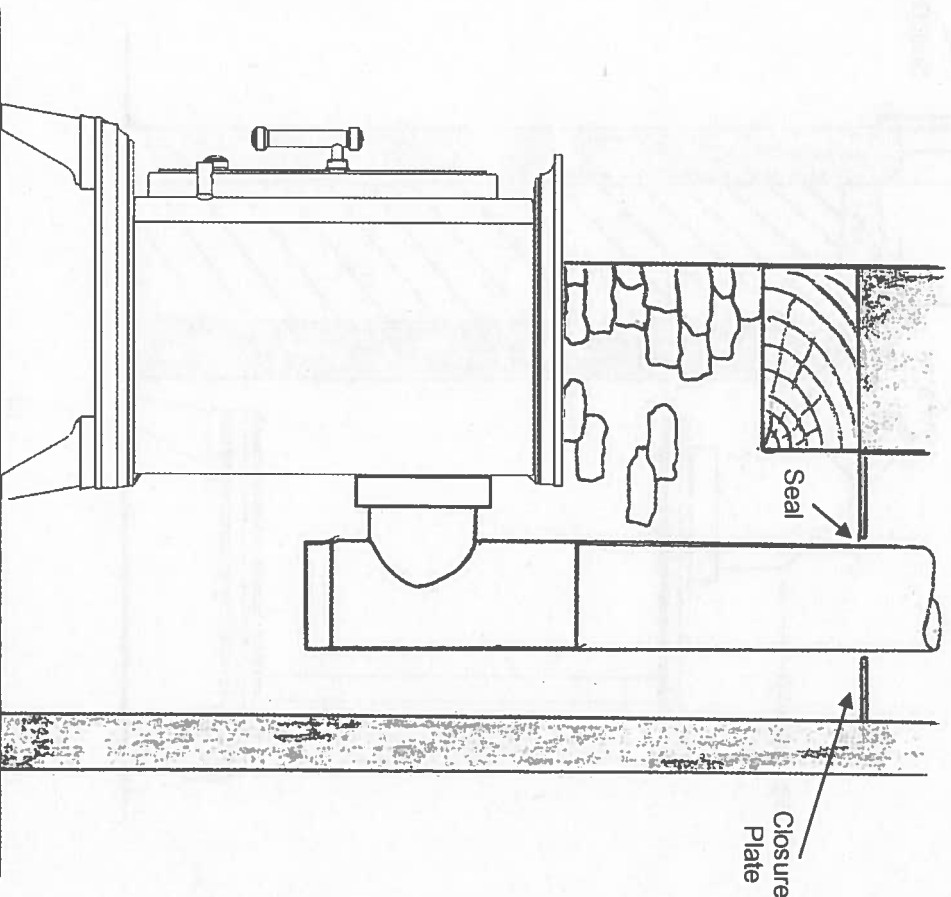

Installation Diagrams

Typical Top Flue Installation using steel closure plate incorporating clean out door for chimney sweeping

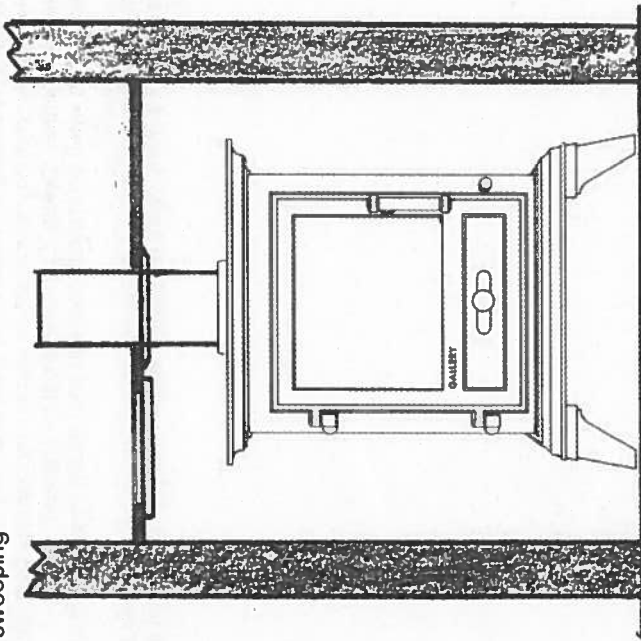

Ideally, the old fireplace should be filled in so that there is a smooth streamlined entry into the flueway.

The length of any horizontal run of the flue pipe must not exceed the flue outlet diameter on the stove.

It is essential that all connections between the stove and chimney-flue are sealed and made airtight.

Both chimney and flue pipe must be accessible for cleaning and if ALL parts of the chimney cannot be reached through the stove, a soot door must be fitted to enable this to be done.

The Primary Air Sealing Plate is located on the front of the grate. To locate in position, slacken the two screws beneath the grate and pull forward, then close the door fully, open door and tighten screws.

Positioning of Appliance

The stove can be recessed in a suitable sized fireplace but a permanent free air gap of at least 100mm must be left around the sides and top to obtain maximum heat output and for access to the rear of the stove. There should not be any combustible material within a distance of 600mm from any surface of the stove. Furniture and general soft furnishings should not be within 900mm of any of the stove surfaces including the stove pipe. In all instances the stove should be positioned on a non-combustible hearth. Allow an apron of at least 300mm at the front of the stove and 150mm on either side. The hearth on which the stove is to be placed should not be less than 125mm thick if the floor is made of combustible material, and care should be taken to level the stove and secure the hearth. If existing floors do not have adequate load bearing capacity then suitable modifications to load bearing plates must be adopted.

When the stove is desired position mark hearth through holes in feet, remove stove drill and plug hearth for securing stove and levelling. See typical flue connection methods illustrated.

Upon completion of installation, the appliance should be checked under fire for soundness of joints and seals, and also that all smoke and fumes are taken from the appliance, up the chimney and emitted safely.

Care should be taken that all flues, hearths, and combustion air supplies are in accordance with the current Building Regulations, Local Authority By-laws, British Standards and Codes of Practice—the Firefox 5 Clean Burn II has no ventilation requirement. Considerations and provisions must be made for any other appliances requiring ventilation. An extractor fan must not be used in the same location as the appliance.

This appliance is not to be used with a shared chimney.

Operating Instructions

Primary Air

Primary air is controlled via the sliding vents in the bottom of the door; this provides a conventional air draught to the bed of the fire. (+) indicates more air, (-) indicates less air. To adjust, slightly turn the knob anti-clockwise to loosen, then move sideways. When in the desired position, turn the knob clockwise until tight.

Typical Rear Flue Installation with clean out door

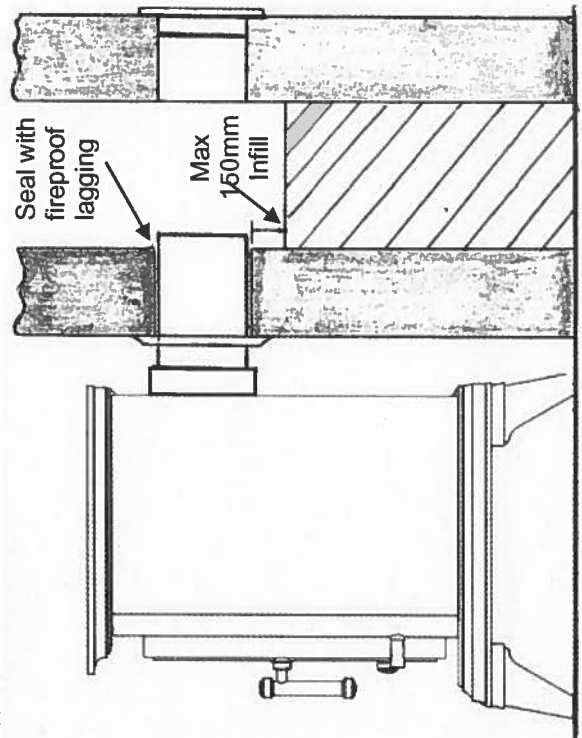

Secondary Air

Secondary air is controlled via the sliding vent above the door, it is this 'airwash' that keeps a clean and uninterrupted view of the fire, also aiding in good secondary combustion of fuel and reducing emissions into the chimney and environment. To adjust the secondary air intake, simply move the slider left (-) for less air or right (+) for more air.

The stove has a pre-determined amount of fixed air supply on the primary and secondary air sliders. This is factory set and should not be adjusted or altered as it facilitates the clean burn function.

Because of the pre-set air supply it is important that the flue draught requirements are adhered to, i.e. minimum = 12 pascals, maximum = 15 pascals. If the flue draught exceeds the maximum requirements then over firing can occur and suitable measures to control draught must be adopted.

Note: Over firing due to fixed air supply will not be dangerously high but efficiency may be compromised.

Damper Assembly (optional)

When burning wood only, a flue damper assembly may be fitted. When the damper is set in the open position the chimney draws at full draught, increasing the volume of air flow through the stove and flue. Shutting the damper restricts the flow, slowing the rate of burning. This is an after market product and will be of the type with positive open and closed indication to prevent misunderstanding.

THE FLUE DAMPER SHOULD NOT BE FITTED WHEN BURNING SOLID FUELS

De-Ashing

It is important that the riddler is used to remove the ash to ensure an airflow through the firebed and allow the fire to burn over the entire area of the grate. Insert peg on operating tool into hole in riddling rod, draw tool forwards and backwards with a slow positive action. Set rod in back position after de-ashing.

Notes On Wood Burning

Wood burns best on a bed of ash and it is therefore only necessary to remove surplus ash from the grate occasionally.

Burn only dry, well seasoned wood, which should have been cut, split and stacked for at least 12 months, with free air movement around the sides of the stack to enable it to dry out.

Burning wet or unseasoned wood will create tar deposits in the stove and chimney and will not produce a satisfactory heat output.

The clean burn function will be compromised if: the maximum fuel load is exceeded; the fuel is not dry/seasoned correctly; the fuel is contaminated i.e. paint, tar resins; or if the flue draught is insufficient.

Notes On Solid Fuel Burning

Always de-ash before refuelling and do not let the ash build up to the underside of the grate bars. Solid fuel produces ash, which if allowed to build up will stifle the air flow through the grate and eventually cause the fire to die.

5) Chimney Fire

Identified by loud roaring sounds, dense smoke and sparks exiting chimney. Shut down air supply to stove by closing air vents, close stove door fully, call fire brigade immediately. Regular chimney maintenance will prevent chimney fires. Seek advice from a Qualified Chimney Sweep. Chimneys must be checked annually more often when bituminous coal and poor quality smoky fuels are used.

If this appliance is well maintained and used correctly in accordance with these instructions it will give many years of efficient service and prove to be an excellent investment.

Troubleshooting

1) Poor heat output

- A) Stove too small for a room.
Seek advice from a Qualified Heating Engineer as to (KW) output required for room size as a guideline the volume of the room in cubic feet divided by 500 i.e. room 15'x15'x8' would require 3.6kw approx.
- B) Chimney and/or flue pipe restricted, room ventilation restricted.
On installation these will have been checked but regular maintenance is necessary as conditions can change i.e. soot build up, birds nesting, masonry fall, dust build up or furniture blocking vents.
- C) Poor quality fuel.
Only burn dry seasoned timber, soft woods have a lower heat output than hard woods per hour. Solid fuels vary in heat value check with your coal merchant as to suitability.

2) Dirty Glass Panel

- A) Generally caused by poor fuel quality, see (1c)
- B) Use secondary air slide (Airwash) for glass panel
- C) Fire burning to low, open air vents on stove create hot fire this may 'burn' glass clean.
- D) If glass requires cleaning use glass cleaner recommended by your supplier, only use glass cleaner or cold glass. DO NOT USE any abrasifs or scrapers these will scratch glass causing tar build up harder to remove.

3) Unburnt Fuel In Firebox

Insufficient air reaching fuel. Open primary air slide, this will supply combustion air to burn fuel fully (unless it has reached a 'point of return')
Check ash pan is full, empty if required, grate may be blocked de-ash with riddler, check for jammed clinker or nails in grate when fires out and cold.

4) Smoke And Furnes Entering Room

These are very dangerous and must NOT be tolerated. Open window and allow fire to burn out, seek expert advice immediately. DO NOT USE stove until the problem is solved. A list of Qualified Engineers is available from

UK Solid Fuel Association
7 Swanwick Court, Alfreton
Derbyshire DE557AS
Tel- 0845-601-4406

R.o.l.

Irish National Fireplace Organisation
162 Chapel Street, Dublin
Tel-016801-5959

With some solid fuels a residue of burnt fuel or clinker will accumulate on the grate, allow the fire to go out periodically to remove this.
We cannot stress firmly enough how important it is to empty the ash pan regularly. Air passing through the firebed cools the grate. Distortion or burning out the grate bars is nearly always caused by ash being allowed to build up the underside of the grate.

Recommended Fuels

Seasoned wood—moisture content less than 20%
Solid fuel—Anthracite large nuts, briquette smokeless fuel i.e. Ancit, Phurnacite, Taybrite, Homefire Ovals suitable for closed appliances.

Please note that when refuelling with solid fuel do not pile fuel higher than 30 degrees from the front bar rearwards—overfuelling can produce temperatures beyond the designed rating of the appliance, causing damage to internal parts.

Lighting The Stove

We recommend that you have two or three small fires before you operate your stove to its maximum heat output. This is to allow the paint to cure and castings to relax and consolidate location we recommend 'running in' procedure after long shutdowns to preserve life of stove. During this you may notice an unpleasant smell. It is not toxic, but for your comfort we would suggest that during this period you leave all doors and windows open.

First, load the fire with starting fuel i.e. paper, dry kindling timber and/or fire lighters in the mode chosen, either wood or coal.

Light the fire at base leaving all air controls open. Allow the fuel to reach a steady glow and build the fire up gradually. Once you have a good fire established across the grate bed, further fuel can be added as required.

When your fuel is well alight you can start to restrict the primary air intake. If you are burning only wood, the primary air control can be fully closed. If you are burning solid fuel you will require more primary air. Your stove is burning with maximum efficiency when a bright fire is achieved using minimum air inlet.

The stove can be banked up for long periods. When burning solid fuel empty the ashpan. Open air controls and let the fire burn brightly for a short period. Refuel and close air controls, the exact setting required will depend on the fuel used and the chimney draw so some practice may be necessary. To revive the fire, open air controls until the fire is burning brightly, de-ash if necessary (solid fuel only) and refuel. Set air controls as required.

This appliance is designed to be operated with the door closed. Except for refuelling, not only is it unsafe to operate with the door open but the appliance efficiency will be reduced dramatically.

Solid Fuels

We recommend the majority of approved manufactured smokeless fuels. Household coal (bituminous coal), which is 'Smoky' fuel, can be burned in areas that are NOT smoke controlled but the clean burn function will not be applicable. The use of household coal is not recommended. Use as an incinerator is not recommended as fumes from plastics etc will cause pollution to the atmosphere and will damage stoves internals.

PETROLEUM COKE FUELS OR HOUSEHOLD WASTE SHOULD NOT BE BURNT ON THIS APPLIANCE

Should any difficulties arise over fuel quality or suitability, consult your local supplier or the Solid Fuel Advisory Service.

Safety Notes For Your Guidance

FIRES CAN BE DANGEROUS—Always use a fire guard to BS6539 specification in the presence of children, the elderly or the infirm.
Inform all persons the dangers of high temperatures during operation of appliance including the stove pipe use operating tools provided.

DO NOT OVER FIRE—it is possible to fire the stove beyond its design capacity, this could damage the stove, so watch for signs of overfiring—if any part of the stove starts to glow red, the fire is in an overfire situation, and the controls should be adjusted accordingly. Never leave the stove unattended for long periods without adjusting the controls to a safe setting—careful air supply control should be exercised at all times.

Warning—Fume Emissions

Properly installed and operated, this appliance will not emit fumes. Occasional fumes from de-ashing and refuelling may occur. Persistent fume emission must not be tolerated.

If fume emission does persist, then following immediate action should be taken—

1. Open doors and windows to ventilate the room.
 2. Let the fire out, or eject and safely dispose of fuel from the appliance.
 3. Check for flue chimney blockage, and clean if required.
- Do not attempt to relight the fire until the cause has been identified. If necessary, seek professional advice.

DO NOT FIT AN EXTRACTOR FAN IN THE SAME ROOM AS THIS APPLIANCE

Seasonal Maintenance

If the appliance is not to be used for any length of time, e.g. summer months, then it is recommended that the appliance is cleaned out thoroughly. Air slides should be lightly oiled and left partially open to allow circulation of air. Regular monitoring of internals will highlight condensation problems or water ingress. If these problems occur then the appliance needs drying and the cause of the problem investigating. It is advisable that after a seasonal shutdown the appliance is re-cleaned. Remove baffle plate, brick linings, check operation of grate, check flue for any possible blockages. It is advisable to have the chimney swept at least once or even twice per year. If the appliance is in constant use, the use of bituminous coal or poor quality wood makes flues soot and tar up more frequently.

Basic maintenance can be carried out by the appliance operator, i.e. removal of baffle plate, bricks, grate, glass replacement and must be done when the appliance is cold.

Any structural repairs, i.e. panel collar replacement or stove pipe must be carried out by a suitably qualified engineer.

General Maintenance

Baffle Plate

This should be removed at least once a month to prevent any build up of soot or fly ash which could lead to blocked flueways and dangerous fume emission. If the baffle plate is removed the chimney/flueway can be swept through the appliance.

Baffle Plate Removal and Replacement

Note position before removal. To remove baffle plate, lift up and remove one side brick left or right. The baffle plate can now be manipulated out of the stove door opening. Remove the remaining back and side brick—as the bricks are free-standing no damage can now occur due to bricks falling over.

To replace, place rear brick in position and one side brick. Manipulate baffle into position and fit remaining side brick. Make sure all parts are located.

Grate Removal

The stove has a single rotating grate operated by an attached riddling rod. To remove, unscrew control knob and rotate grate out of its guide hole. The centre grate can now be removed. To replace grate, reverse this procedure. Note position of grate riddling rod as it connects to grate. The hook on the end of the rod passes under and up through the arm hole on the grate. If the removal of the outer grate is required then the baffle plate, rear and side bricks will require removal. The outer grate will then lift out off it's stops.

Stove Body

The stove is finished with a heat-resistant paint and this can be cleaned with a soft brush. Do not clean whilst the stove is hot, wait until it has cooled down. The finish can be renovated with a suitable brand of paint.

Glass Panels

Clean the glass panels when cool with a proprietary glass cleaner. Highly abrasive substances should be avoided as these can scratch the glass and make subsequent cleaning more difficult. Wet logs on heated glass, a badly aimed poker or heavy slamming of the doors could crack the glass panels. The glass will not fracture from heat.

Chimney

Check your chimney each year before starting to use your stove for the winter. Birds may have nested in the chimney or the masonry may have cracked. Both chimney and flue pipe must be swept at least once a year.

To avoid a build up of soot on the baffle (the plate inside the stove above the grate) this must be removed and cleaned periodically. This plate locates the back and side firebricks so note its position before removal. To remove, lift plate and remove one side brick, this will allow plate to drop and aid removal. To replace, position baffle plate on back and side brick, lift plate and replace remaining brick, make sure it has located in position. This must be done when the stove is cold.

For efficient burning of your appliance, make sure the grate is clear of burnt debris i.e. nails etc.

Stove Installation, Operating and Maintenance Instructions

INSTALLATION INSTRUCTIONS

Check that the chimney is in good condition, dry, free from cracks and obstructions. The diameter of the flue should not be less than 150mm and not more than 230mm. If any of these requirements are not met, the chimney should be lined by a suitable method.

The chimney height and the position of the chimney terminal should conform to Building Regulations.

A flue draught of minimum 1.5mm to a maximum 2.5mm water gauge is required for satisfactory appliance performance. The flue draught should be checked under fire at high output and if it exceeds the recommended maximum, a draught stabiliser must be fitted so that the rate of burning can be controlled, and to prevent overfiring.

If you have any doubts about the suitability of your chimney, consult your local dealer/stockist.

The chimney must be swept before connection to the stove.

An existing fireplace opening can be bricked up or sealed with a register plate. A short length of flue pipe no smaller in diameter than the stove flue outlet or the manufacturer's stated flue size may then be used to connect the stove to the chimney. This flue pipe should be of cast iron, 316 grade stainless steel or vitreous enamelled, nominal thickness 1.2mm. Ensure that the pipe end is no closer than 76mm to the side or rear chimney walls.

Ideally, the old fireplace should be filled in so that there is a smooth streamlined entry into the flueway.

The length of any horizontal run of flue pipe must not exceed the flue outlet diameter on the stove—152mm.

It is essential that all connections between the stove and chimney-flue are sealed and made airtight.

Both the chimney and flue pipe must be accessible for cleaning and if ALL parts of the chimney cannot be reached through the stove, a soot door must be fitted in a suitable position to enable this to be done.

The stove can be recessed in a suitable sized fireplace but a permanent free air gap must be left around the sides and top to obtain maximum heat output and for access to the rear of the stove. There should not be any combustible material within a distance of 900mm from any surface of the stove. In all instances the stove should be positioned on an incombustible hearth. Allow an apron of at least 300mm at the front of the stove and 150mm on either side. The hearth on which the stove is to be placed should not be less than 125mm thick if the floor is made of combustible material, and care should be taken to level the stove.

Upon completion of installation, the appliance should be checked under fire for soundness of joints and seals, and also that all smoke and fumes are taken from the appliance, up the chimney and emitted safely.

Care should be taken that all flues, hearths, and combustion air supplies are in accordance with the current Building Regulations, Local Authority Bye-Laws, British Standards and Codes of Practice.

OPERATING INSTRUCTIONS

Primary Air

Primary air is controlled via the sliders or spinwheels in the bottom of the doors, this provides a conventional air draught to the bed of the fire.

Secondary Air

Secondary air is controlled via the slider or spinwheels above the doors, it is this 'airwash' that keeps a clean and uninterrupted view of the fire, also aiding in good secondary combustion of the fuel and reducing emissions into the chimney and environment.

Damper Assembly (optional)

When burning wood, the flue damper assembly may be fitted. When the damper is set in the open position the chimney draws at full draught, increasing the volume of air flow through the stove and flue. Shutting the damper restricts the flow, slowing the rate of burning.

THE FLUE DAMPER SHOULD NOT BE FITTED WHEN BURNING SOLID FUELS

It is important that the riddler is used to remove the ash to ensure an airflow through the firebed and allow the fire to burn over the entire area of the grate. The ashpan should be emptied at least daily and ash should never be allowed to build up over a period of time as this will result in damage to the firebars.

Notes On Wood Burning

Wood burns best on a bed of ash and it is therefore only necessary to remove surplus ash from the stove occasionally.

Burn only dry, well seasoned wood, which should have been cut, split and stacked for at least 12 months, with free air movement around the sides of the stack to enable it to dry out. Burning wet or unseasoned wood will create tar deposits in the stove and chimney and will not produce a satisfactory heat output.

Notes on Solid Fuel Burning

Always de-ash before refuelling and do not let the ash build up to the underside of the grate bars. Solid fuel produces ash, which if allowed to build up will stifle the air flow through the grate and eventually cause the fire to die.

With some solid fuels a residue of burnt fuel or clinker will accumulate on the grate, allow the fire to go out periodically to remove this.

We cannot stress firmly enough how important it is to empty the ashpan regularly. Air passing through the firebed cools the grate bars. Distortion or burning out of the grate bars is nearly always caused by ash being allowed to build up to the underside of the grate.

Lighting The Stove

We recommend that you have two or three small fires before you operate your stove to its maximum heat output. This is to allow the paint to cure in steadily and to give a long service life of the paint finish. During this curing in process you may notice an unpleasant smell. It is non-toxic, but for your comfort we would suggest that during this period you leave all doors and windows open.

First, load the fire with starting fuel, i.e. paper, dry sticks and/or fire lighters in the mode chosen, either wood or coal.

Light the fire at base leaving all air controls open. Allow the fuel to reach a steady glow and build the fire up gradually. Once you have a good fire established across the grate bed, further fuel can be added as required.

When your fuel is well alight you can start to restrict the primary air intake. If you are burning only wood, the primary air control can be fully closed. If you are burning solid fuel you will require more primary air.

The stove can be banked up for long periods. When burning solid fuel empty the ashpan. Open air controls and let the fire burn brightly for a short period. Refuel and close air controls, the exact setting required will depend on the fuel used and the chimney draw so some practice may be necessary. To revive the fire, open air controls until the fire is burning brightly, de-ash if necessary (solid fuel only) and refuel. Set air controls as required.

Solid Fuels

We recommend the majority of approved manufactured smokeless fuels. Household coal, which is a 'smokey' fuel, can also be used but note that different types will give different performances.

PETROLEUM COKE FUELS OR HOUSEHOLD WASTE SHOULD NOT BE BURNT ON THIS APPLIANCE

Should any difficulties arise over fuel quality or suitability, consult your local supplier or the Solid Fuel Advisory Service.

Safety Notes For Your Guidance

FIRES CAN BE DANGEROUS—Always use a fireguard in the presence of children, the elderly or the infirm.

DO NOT OVERFIRE—it is possible to fire the stove beyond its design capacity, this could damage the stove, so watch for signs of overfiring—if any part of the stove starts to glow red, the fire is in an overfire situation, and the controls should be adjusted accordingly. Never leave the stove unattended for long periods without first adjusting the controls to a safe setting—careful air supply control should be exercised at all times.

Warning—Fume Emission

Properly installed and operated, this appliance will not emit fumes. Occasional fumes from de-ashing and refuelling may occur. Persistent fume emission must not be tolerated.

If fume emission does persist, then the following immediate action should be taken—

1. Open doors and windows to ventilate the room.
2. Let the fire out, or eject and safely dispose of fuel from the appliance.
3. Check for flue chimney blockage, and clean if required.
4. Do not attempt to relight the fire until the cause has been identified. If necessary, seek professional advice.

DO NOT FIT AN EXTRACTOR FAN IN THE SAME ROOM AS THIS APPLIANCE

GENERAL MAINTENANCE

Throat Plate

This should be removed at least once a month to prevent any build up of soot or fly ash which could lead to blocked flueways and dangerous fume emission. If the throat plate is removed the chimney/flueway can be swept through the appliance.

Stove Body

The stove is finished with a heat-resistant paint and this can be cleaned with a soft brush. Do not clean whilst the stove is hot, wait until it has cooled down. The finish can be renovated with a suitable brand of paint.

Glass Panels

Clean the glass panels when cool with a proprietary glass cleaner. Highly abrasive substances should be avoided as these can scratch the glass and make subsequent cleaning more difficult. Wet logs on heated glass, a badly aimed poker or heavy slamming of the doors could crack the glass panels. The glass will not fracture from heat.

Chimney

Check your chimney each year before starting to use your stove for the winter. Birds may have nested in the chimney or the masonry may have cracked. Both chimney and flue pipe must be swept at least once a year.

Primary Air Sealing Plate

This is located on the front of the grate. To locate in position, slacken the two screws beneath the grate and pull forward, then close the door fully, open door and tighten the screws.

To avoid a build up of soot on the baffle plate (the plate inside the stove above the grate) this must be removed & cleaned periodically. This plate locates the back & side firebricks so note its position before removal. To remove, lift plate and remove one side brick, this will allow plate to drop and aid removal. To replace, position baffle plate on back & side brick, lift plate and replace remaining brick, make sure it has located in position.

For efficient burning of your appliance, make sure the grate is clear of burnt debris i.e. nails etc.